

- de** Montageanleitung
- en** Mounting instructions
- fr** Instructions de montage
- sv** Monteringsinstruktion
- nl** Montage-handleiding
- it** Istruzioni di montaggio
- fi** Asennusohje
- es** Instrucciones de montaje
- da** Monteringsvejledning
- pl** Instrukcja montażu
- cz** Montážní návod
- hu** Szerelési útmutató
- el** Οδηγίες εγκατάστασης
- tr** Montaj talimatları
- zh** 安裝指導

- Ventile PN16
- Valves PN16
- Vannes PN16
- Ventiler PN16
- Afsluiters PN16
- Valvole PN16
- Venttiilit PN16
- Válvulas PN16
- Ventiler PN16
- Zawory PN16
- Ventily PN16
- Szelepek PN16
- Βάνες PN16
- PN16 vanalar
- 阀门 PN16

VVP47..
VXP47..
VMP47..

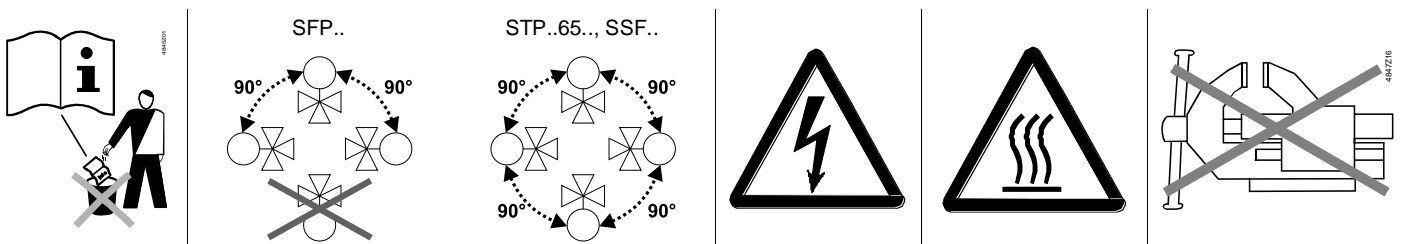

VVP47..

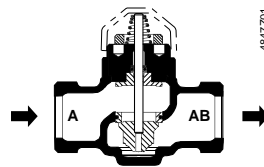

4847Z01



A → AB 0...100%

VXP47..

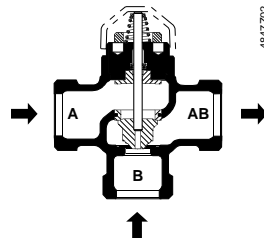

4847Z02

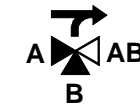

A → AB 0...100%
B → AB 70...0%



VMP47..

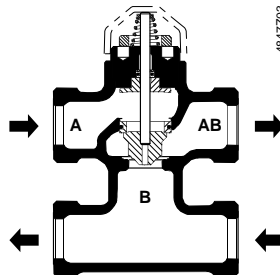

4847Z03

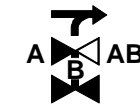

A → AB 0...100%
B → AB 70...0%



AL50 (V..P47.. + SFP..)

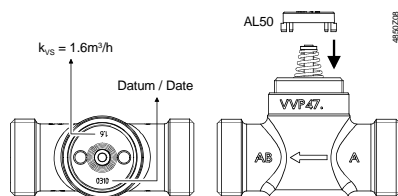

4850Z08

V..P47.. + SSF..

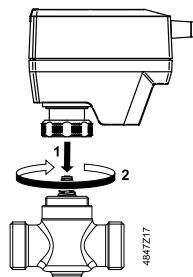

4847Z17

V..P47.. + SFP..

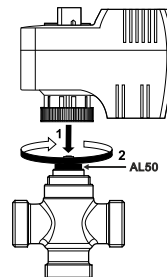

AL50

V..P47.. + ASA80 + STP..65..

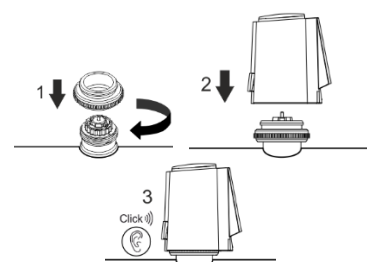

VVP47..

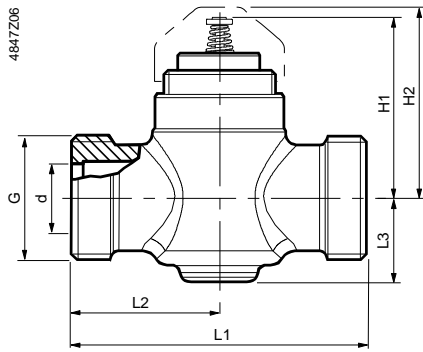

VXP47..

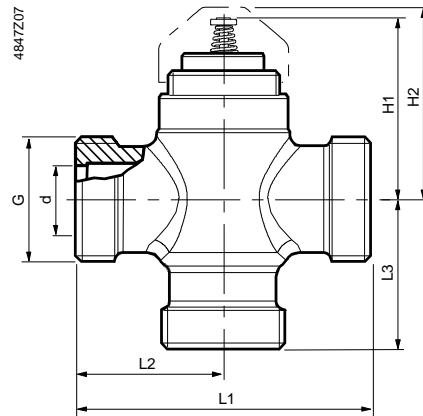

VMP47..

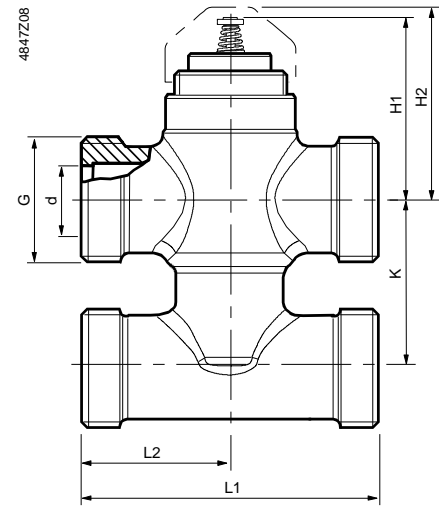

	DN	G	d	H1	H2	L1	L2	L3	[kg]
		["]	[mm]	[mm]	[mm]	[mm]	[mm]	[mm]	[kg]
VVP47.10-0.25...1.6	10	G½B	10.5	46	≈ 49	60	30	19	0.33
VVP47.15-2.5	15	G¾B	14	46	≈ 49	65	32.5	19	0.36
VVP47.20-4	20	G1B	20	49	≈ 52	80	40	23	0.46

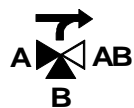

	DN	G	d	H1	H2	L1	L2	L3	[kg]
		["]	[mm]	[mm]	[mm]	[mm]	[mm]	[mm]	[kg]
VXP47.10-0.25...1.6	10	G½B	10.5	46	≈ 49	60	30	30	0.34
VXP47.15-2.5	15	G¾B	14	46	≈ 49	65	32.5	32.5	0.38
VXP47.20-4	20	G1B	20	49	≈ 52	80	40	40	0.51



	DN	G	d	H1	H2	K	L1	L2	[kg]
		["]	[mm]	[mm]	[mm]	[mm]	[mm]	[mm]	[kg]
VMP47.10-0.25...1.6	10	G½B	10.5	46	≈ 49	40	60	30	0.41
VMP47.15-2.5	15	G¾B	14	46	≈ 49	40	65	32.5	0.50

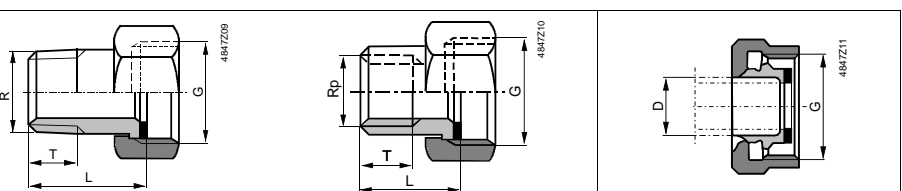

ALG...		DN	G ["]	R ["]	Rp ["]	L [mm]	T [mm]	SERTO SO 21...	D [mm]
ALG132	VVP47.10-0.25...1.6	10	G½	R¾		≈ 24	≈ 10	SO 21-12-1/2"	12
ALG133	VXP47.10-0.25...1.6							SO 21-14-1/2"	14
2 x ALG132	VMP47.10-0.25...1.6							SO 21-15-1/2"	15
ALG142	VVP47.15-2.5	15	G¾	R½		≈ 29.5	≈ 13	SO 21-17-3/4"	17
ALG143	VXP47.15-2.5							SO 21-18-3/4"	18
2 x ALG142	VMP47.15-2.5								
ALG152	VVP47.20-4	20	G1		Rp½	≈ 23			
ALG153	VXP47.20-4								